

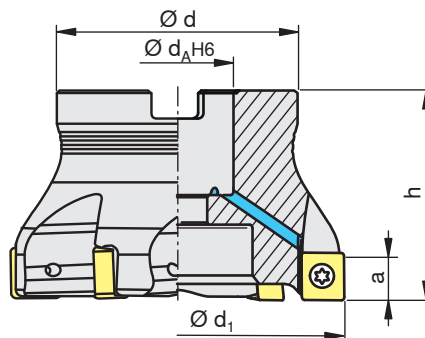

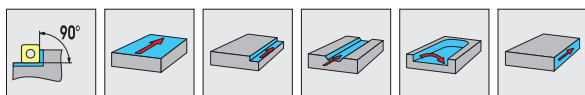





MaxiMill 491 system

A491-12

B15



d_1 [mm]	Type, description	h [mm]	d [mm]	d_A [mm]	a [mm]	z	n_{max} [min ⁻¹]	[Nm]			
40	A491.40.R.03-12	40	38	16	8	3	11500	3.2	SNHU 1204..		E01
40	A491.40.R.04-12	40	38	16	8	4	11500	3.2	SNHU 1204..		E01
50	A491.50.R.04-12	40	43	22	8	4	9800	3.2	SNHU 1204..		E02
50	A491.50.R.05-12	40	43	22	8	5	9800	3.2	SNHU 1204..		E02
63	A491.63.R.05-12	40	48	22	8	5	8500	3.2	SNHU 1204..		E02
63	A491.63.R.06-12	40	48	22	8	6	8500	3.2	SNHU 1204..		E02
80	A491.80.R.06-12	50	58	27	8	6	7400	3.2	SNHU 1204..		E02
80	A491.80.R.08-12	50	58	27	8	8	7400	3.2	SNHU 1204..		E02
100	A491.100.R.07-12	50	78	32	8	7	6500	3.2	SNHU 1204..		E02
100	A491.100.R.10-12	50	78	32	8	10	6500	3.2	SNHU 1204..		E02
125	A491.125.R.08-12	63	88	40	8	8	5700	3.2	SNHU 1204..		E02
125	A491.125.R.12-12	63	88	40	8	12	5700	3.2	SNHU 1204..		E02
160	A491.160.R.09-12	63	98	40	8	9	5000	3.2	SNHU 1204..		E02
160	A491.160.R.14-12	63	98	40	8	14	5000	3.2	SNHU 1204..		E02

					
E01	11036880	11610311	11450867	8095012000	4425
E02		11610311	11450867	8095012000	